

Lasting Connections

RC 120

ISTRUZIONI PER L'USO
INSTRUCTION MANUAL
BETRIEBSANWEISUNG
MANUEL D'INSTRUCTIONS
INSTRUCCIONES DE USO
MANUAL DE INSTRUÇÕES

GEBRUIKSAANWIJZING
BRUKSANVISNING
BRUGERVEJLEDNING
BRUKSANVISNING
KÄYTTÖOHJEET
ΟΔΗΓΙΕΣ ΧΡΗΣΗΣ

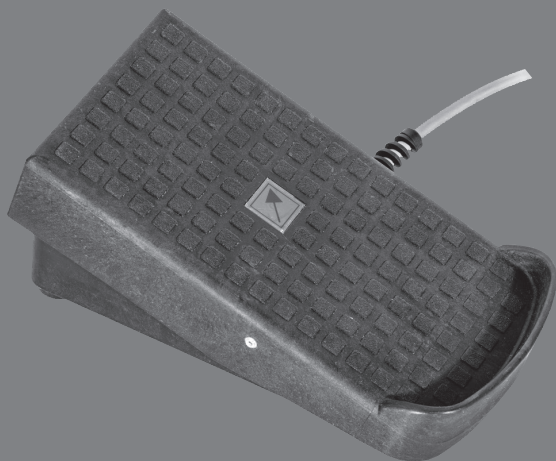



Cod. 91.08.382
Data 27/06/2019
Rev.

ITALIANO	3
ENGLISH.....	7
DEUTSCH.....	11
FRANÇAIS.....	15
ESPAÑOL	19
PORTUGUÊS	23
NEDERLANDS.....	27
SVENSKA.....	31
DANSK.....	35
NORSK.....	39
SUOMI	43
ΕΛΛΗΝΙΚΑ.....	47
4 Targa dati, Rating plate, Leistungsschilder, Plaque données, Placa de características, Placa de dados, Technische gegevens, Märklåt, Dataskilt, Identifikasjonsplate, Arvokilpi, πινακίδα χαρακτηριστικων.....	51
5 Significato targa dati, Meaning rating plate, Bedeutung der Angaben auf dem Leistungsschild, Signification de la plaque des données, Significado de la etiqueta de los datos, Significado da placa de dados, Betekenis gegevensplaatje, Märklåt, Betydning af oplysningerne dataskilt, Beskrivelse informasjonsskilt, Kilven sisältö, Σημασία πινακίδας χαρακτηριστικών	52
6 Schema-Connettori, Diagram-Connectors, Schaltplan-Verbinder, Schéma-Connecteurs, Esquema-Conectores, Diagrama-Conectores, Schema-Verbindingen, kopplingschema-Kontaktton, Oversigt-Konnektorer, Skjema-Skjøtemunnstykker, Kytentäkaavio-Liittimet, Διαγραμμα-Συνδετηρες.....	53
7 Lista ricambi, Spare parts list, Ersatzteilverzeichnis, Liste de pièces détachées, Lista de repuestos, Lista de peças de reposição, Lijst van reserve onderdelen, Reservdelslista, Reservedelsliste, Liste over reservedeler, Varaosaluettelo, καταλογος ανταλλακτικων.....	54
8 Simbologia, Symbols, Symbole, Symbologie, Símbolos, Simbolos, Symbolen, Symboler, Symboler, Symbolenes forklaring, Symbolit, Συμβολα.....	56

INDICE

1 AVVERTENZE	5
1.1 Ambiente di utilizzo.....	5
2 RC 120.....	5
2.1 Generalità.....	5
3 CARATTERISTICHE TECNICHE.....	6

1 AVVERTENZE



Prima di iniziare qualsiasi operazione siate sicuri di aver ben letto e compreso questo manuale. Non apportate modifiche e non eseguite manutenzioni non descritte.

Il produttore non si fa carico di danni a persone o cose, occorsi per incuria nella lettura o nella messa in pratica di quanto scritto in questo manuale.



Per ogni dubbio o problema circa l'utilizzo dell'impianto, anche se qui non descritto, consultare personale qualificato.



1.1 Ambiente di utilizzo

- Questo apparecchio deve essere usato solo a scopo professionale in un ambiente industriale.
Il costruttore non risponderà di danni provocati dall'uso dell'impianto in ambienti domestici.
- L'impianto deve essere utilizzato in ambienti con temperatura compresa tra i -10°C e i +40°C (tra i +14°F e i +104°F).
L'impianto deve essere trasportato e immagazzinato in ambienti con temperatura compresa tra i -25°C e i +55°C (tra i -13°F e i 131°F).
- L'impianto deve essere utilizzato in ambienti privi di polvere, acidi, gas o altre sostanze corrosive.
- L'impianto deve essere utilizzato in ambienti con umidità relativa non superiore al 50% a 40°C (104°F).
L'impianto deve essere utilizzato in ambienti con umidità relativa non superiore al 90% a 20°C (68°F).
- L'impianto deve essere utilizzato ad una altitudine massima sul livello del mare di 2000m (6500 piedi).

2 RC 120

2.1 Generalità



La connessione del comando a distanza all'apposito connettore, presente sui generatori, ne attiva il funzionamento. Tale connessione può avvenire anche con impianto acceso.

Con il comando RC connesso, il pannello comandi del generatore rimane abilitato ad effettuare qualsiasi modifica. Le modifiche sul pannello comandi del generatore vengono riportate anche sul comando RC e viceversa.

La corrente di uscita viene variata da un valore minimo ad uno massimo (impostabili da setup) variando l'angolo tra il piano d'appoggio del piede e la base del pedale. Un microinterruttore fornisce, alla minima pressione, il segnale d'inizio saldatura.

"Consultare il manuale d'uso".

3 CARATTERISTICHE TECNICHE

RC 120

Tensione di alimentazione U1	15Vdc
Potenza massima assorbita (W)	0.2W
Corrente assorbita I1	15mA
Norme di costruzione	EN 60974-1/EN 60974-10
Dimensioni (lxpxh)	260x125x160 mm
Peso	2.2 Kg.
Cavo di alimentazione	6m

INDEX

1 WARNING	9
1.1 Work environment.....	9
2 RC 120.....	9
2.1 General.....	9
3 TECHNICAL SPECIFICATIONS	10

1 WARNING



Before performing any operation on the machine, make sure that you have thoroughly read and understood the contents of this booklet. Do not perform modifications or maintenance operations which are not prescribed.

The manufacturer cannot be held responsible for damages to persons or property caused by misuse or non-application of the contents of this booklet by the user.



Please consult qualified personnel if you have any doubts or difficulties in using the equipment.



1.1 Work environment

- This equipment shall be used for professional applications only, in industrial environments.
The manufacturer shall not be held responsible for any damages caused by the use of the equipment in domestic environments.
- The equipment must be used in environments with a temperature between -10°C and $+40^{\circ}\text{C}$ (between $+14^{\circ}\text{F}$ and $+104^{\circ}\text{F}$).
The equipment must be transported and stored in environments with a temperature between -25°C and $+55^{\circ}\text{C}$ (between -13°F and 131°F).
- The equipment must be used in environments free from dust, acid, gas or any other corrosive substances.
- The equipment shall not be used in environments with a relative humidity higher than 50% at 40°C (104°F).
The equipment shall not be used in environments with a relative humidity higher than 90% at 20°C (68°F).
- The system must not be used at an higher altitude than 2,000 metres (6,500 feet) above sea level.

2 RC 120

2.1 General

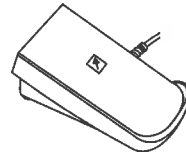

Operation of the remote control is activated when connected to the power sources. This connection can be made also with the system power on.

With the RC control connected, the power source control panel stays enabled to perform any modification. The modifications on the power source control panel are also shown on the RC control and vice versa.

The output current is controlled from a minimum to a maximum value (can be entered from SETUP) by varying the foot pressure on the pedal surface. A microswitch provides the start trigger signal at minimum pressure.

“Consult the instruction manual”.

3 TECHNICAL SPECIFICATIONS

	RC 120
Power supply voltage U1	15Vdc
Potenza massima assorbita (W)	0.2W
Input current I1	15mA
Manufacturing Standards	EN 60974-1/EN 60974-10
Dimensions (lxdxh)	260x125x160 mm
Weight	2.2 Kg.
Power supply cable	6m

INDEX

1 WARNUNG.....	13
1.1 Arbeitsumgebung.....	13
2 RC 120.....	13
2.1 Allgemeines	13
3 TECHNISCHE DATEN	14

1 WARNUNG



Vor Arbeitsbeginn lesen Sie das Anleitungsheft sorgfältig durch und vergewissern Sie sich, ob Sie alles richtig verstanden haben. Nehmen Sie keine Änderungen vor und führen Sie keine hier nicht beschriebenen Instandhaltungsarbeiten durch.

Der Hersteller haftet nicht für Personen- oder Sachschäden, die durch unsachgemäßen Gebrauch oder Nichteinhaltung der Vorgaben dieser Anleitung seitens des Benutzers verursacht werden.



Bei Fragen oder Unklarheiten im Umgang mit dem Gerät wenden Sie sich an Fachpersonal.



1.1 Arbeitsumgebung

- Dieses Gerät darf nur für gewerbliche Zwecke im industriellen Umfeld angewendet werden.
Der Hersteller haftet nicht für Schäden, die durch den Gebrauch der Anlage im Haushalt verursacht wurden.
- Die Anlage darf nur bei Umgebungstemperaturen zwischen -10°C und $+40^{\circ}\text{C}$ (zwischen $+14^{\circ}\text{F}$ und $+104^{\circ}\text{F}$) benutzt werden.
Die Anlage darf nur bei Umgebungstemperaturen zwischen -25°C und $+55^{\circ}\text{C}$ (zwischen -13°F und 131°F) befördert und gelagert werden.
- Die Anlage darf nur in einer Umgebung benutzt werden, die frei von Staub, Säure, Gas und ätzenden Substanzen ist.
- Die Anlage darf nicht in einer Umgebung mit einer relativen Luftfeuchte über 50% bei 40°C (104°F) benutzt werden.
Die Anlage darf nicht in einer Umgebung mit einer relativen Luftfeuchte über 90% bei 20°C (68°F) benutzt werden.
- Die Anlage darf nicht in einer Höhe von mehr als 2000m über NN (6500 Fuß) benutzt werden.

2 RC 120

2.1 Allgemeines

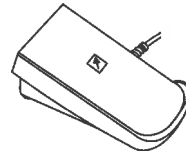

Durch den Anschluss der Fernsteuerung RC am dazu vorgesehenen Anschluss an den Generatoren wird die Fernsteuerung aktiviert. Dieser Anschluss kann auch bei eingeschalteter Anlage erfolgen.

Wenn die Fernsteuerung RC angeschlossen ist, bleibt das Bedienfeld des Generators aktiviert und Änderungen können beliebig ausgeführt werden. Die am Bedienfeld des Generators ausgeführten Änderungen werden auch an der Fernsteuerung RC angezeigt, und umgekehrt.

Kann der Ausgangsstrom zwischen Mindest- und Höchstwert (über SETUP einstellbar) variiert werden, indem das Pedal mit dem Fuß mehr oder weniger stark betätigt wird. Ein Mikroschalter liefert beim geringsten Druck das Signal für den Schweißbeginn.

“Siehe Bedienungsanleitung”.

3 TECHNISCHE DATEN

RC 120

Versorgungsspannung U1	15Vdc
Max. Leistungsaufnahme (W)	0.2W
Stromaufnahme I1	15mA
Konstruktionsnormen	EN 60974-1/EN 60974-10
Abmessungen (LxBxH)	260x125x160 mm
Gewicht	2.2 Kg.
Versorgungskabel	6m

INDEX GENERAL

1 AVERTISSEMENT	17
1.1 Environnement d'utilisation	17
2 RC120	17
2.1 Généralités	17
3 CARACTÉRISTIQUES TECHNIQUES.....	18

1 AVERTISSEMENT



Avant de commencer toute opération, assurez-vous d'avoir bien lu et bien compris ce manuel. N'apportez pas de modification et n'effectuez pas d'opération de maintenance si elles ne sont pas indiquées dans ce manuel.

Le fabricant n'est pas responsable des dommages causés aux personnes ou aux objets en cas de non-respect ou de mise en pratique incorrecte des instructions de ce manuel.



Prière de consulter du personnel qualifié en cas de doute ou de problème sur l'utilisation de l'installation, même si elle n'est pas décrite ici.



1.1 Environnement d'utilisation

- Cet appareil ne doit être utilisé que dans un but professionnel, dans un environnement industriel.
Le fabricant n'est pas responsable des dommages causés en cas d'usage domestique.
- L'installation doit être utilisée dans un local dont la température est comprise entre -10 et +40°C (entre +14 et +104°F). L'installation doit être transportée et stockée dans un local dont la température est comprise entre -25 et +55°C (entre -13 et 131°F).
- L'installation doit être utilisée dans un local sans poussière, ni acide, ni gaz ou autres substances corrosives.
- L'installation ne doit pas être utilisée dans un local dont le taux d'humidité dépasse 50% à 40°C (104°F). L'installation ne doit pas être utilisée dans un local dont le taux d'humidité dépasse 90% à 20°C (68°F).
- L'installation ne doit pas être utilisée à une altitude supérieure à 2000 m au dessus du niveau de la mer (6500 pieds).

2 RC120

2.1 Généralités



Le fonctionnement de la commande à distance est activé dès son branchement sur les générateurs. Ce branchement est également possible sur une installation en marche.

Lorsque la commande RC est branchée, le panneau de commande du générateur reste activé pour toute modification. Les modifications sur le panneau de commande du générateur sont reportées sur la commande RC et inversement. Le courant de sortie peut être ajusté d'une valeur minimale à une valeur maximale par une pression avec le pied sur la pédale. Un micro-contact fournit le signal de début de soudure dès que l'opérateur appuie sur la pédale.

“Consulter le manuel d'instructions”.

3 CARACTÉRISTIQUES TECHNIQUES

RC 120

Tension d'alimentation U1	15Vdc
Puissance maximum absorbée (W)	0.2W
Courant absorbé I1	15mA
Normes de construction	EN 60974-1/EN 60974-10
Dimensions (lxdxh)	260x125x160 mm
Poids	2.2 Kg.
Câble d'alimentation	6m

INDICE

1 ADVERTENCIA	21
1.1 Entorno de utilización	21
2 RC 120.....	21
2.1 Generalidades.....	21
3 CARACTERÍSTICAS TÉCNICAS	22

1 ADVERTENCIA



Antes de comenzar cualquier tipo de operación, tiene que haber comprendido el contenido del presente manual.

No efectúe modificaciones ni mantenimientos no descritos en este manual.

El fabricante no es responsable por daños a personas o cosas causados por una lectura, o una puesta en aplicación negligente de cuanto escrito del contenido de este manual.



En caso de dudas o problemas sobre la utilización del equipo, aunque no se indiquen aquí, consulte con personal cualificado.



1.1 Entorno de utilización

- Este equipo tiene que ser debe utilizarse sólo para fines profesionales en un local industrial.
El fabricante no responde de daños provocados por un uso del equipo en entornos domésticos.
- El equipo debe utilizarse en locales con una temperatura comprendida entre -10°C y +40°C (entre +14°F y +104°F).
El equipo debe transportarse y almacenarse en locales con una temperatura comprendida entre -25°C y +55°C (entre -13°F y 131°F).
- El equipo debe utilizarse en locales sin polvo, ácidos, gases ni otras substancias corrosivas.
- El equipo debe utilizarse en locales con una humedad relativa no superior al 50% a 40°C (104°F).
El equipo debe utilizarse en locales con una humedad relativa no superior al 90% a 20°C (68°F)
- El equipo debe utilizarse a una altitud máxima sobre el nivel del mar de 2000 m (6500 pies).

2 RC 120

2.1 Generalidades

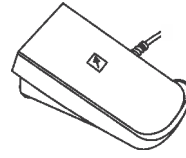

El control remoto se activa al conectarlo a las fuentes de alimentación. Dicha conexión se puede realizar incluso con el sistema activado.

Con el mando RC conectado, el panel de control de la fuente de alimentación

queda habilitado para efectuar cualquier modificación. Las modificaciones en el panel de control de la fuente de alimentación se producen también en el mando RC y viceversa.

La corriente de salida oscila entre un valor mínimo y un valor máximo (configurables desde SETUP) variando la presión del pie sobre la superficie del pedal. Un microinterruptor suministra la señal de comienzo de soldadura al presionar mínimamente el pedal.

"Consulte el manual del usuario".

3 CARACTERÍSTICAS TÉCNICAS

RC 120

Tensión de alimentación U1	15Vdc
Potencia máxima absorbida (W)	0.2W
Corriente absorbida I1	15mA
Normas de fabricación	EN 60974-1/EN 60974-10
Dimensiones (lpxh)	260x125x160 mm
Peso	2.2 Kg.
Cable de alimentación	6m

ÍNDICE GERAL

1 ATENÇÃO	25
1.1 Condições de utilização	25
2 RC 12 / RC 120.....	25
2.1 Generalidades (RC 12).....	25
2.2 Generalidades (RC 120).....	25
3 CARACTERÍSTICAS TÉCNICAS	26

1 ATENÇÃO



Antes de iniciar qualquer tipo de operação na máquina, é necessário ler cuidadosamente e compreender o conteúdo deste manual. Não efectuar modificações ou operações de manutenção que não estejam previstas.

O fabricante não se responsabiliza por danos causados em pessoas ou bens, resultantes da utilização incorrecta ou da não-aplicação do conteúdo deste manual.



Para quaisquer dúvidas ou problemas relativos à utilização do equipamento, ainda que não se encontrem aqui descritos, consultar pessoal qualificado.



1.1 Condições de utilização

- Esta unidade deverá ser apenas utilizada com fins profissionais, numa instalação industrial.
O construtor declina qualquer responsabilidade por eventuais danos provocados pela utilização da instalação em ambientes domésticos.
- O equipamento deve ser utilizado em ambientes cujas temperaturas estejam compreendidas entre -10°C e +40°C (entre +14°F e +104°F).
O equipamento deve ser transportado e armazenado em ambientes cujas temperaturas estejam compreendidas entre -25°C e +55°C (entre -13°F e 131°F).
- O equipamento deve ser utilizado em ambientes sem poeira, ácidos, gases ou outras substâncias corrosivas.
- O equipamento deve ser utilizado em ambientes com humidade relativa não superior a 50%, a 40°C (104°F).
O equipamento deve ser utilizado em ambientes com humidade relativa não superior a 90%, a 20°C (68°F).
- O equipamento deve ser utilizado a uma altitude máxima, acima do nível do mar, não superior a 2000 m (6500 pés).

2 RC 120

2.1 Generalidades

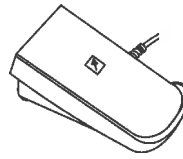

O comando à distância fica operacional ao ser ligado a um gerador. Esta ligação pode ser efectuada com o equipamento activado.

Com o comando RC ligado, o painel de comandos do gerador fica com a capacidade para efectuar qualquer modificação. As modificações no painel de comandos do gerador também são indicadas no comando RC e vice-versa.

A corrente de saída é modificada de um valor mínimo para um valor máximo (podem ser ajustados a partir de DEFINIÇÕES) através da pressão exercida pelo pé na superfície do pedal. Um microinterruptor fornece, à mínima pressão, o sinal de início da soldadura.

“Consultar o manual de instruções”.

3 CARACTERÍSTICAS TÉCNICAS

RC 120

Tensão de alimentação	15Vdc
Potência máxima de entrada (W)	0.2W
Corrente de entrada I1	15mA
Normas de construção	EN 60974-1/EN 60974-10
Dimensões (lxpxh)	260x125x160 mm
Peso	2.2 Kg.
Cabo de alimentação	6m

INHOUDSOPGAVE

1 WAARSCHUWING.....	29
1.1 Gebruiksomgeving.....	29
2 RC 120	29
2.1 Algemene informatie	29
3 TECHNISCHE KENMERKEN	30

1 WAARSCHUWING



Voor het gebruik van de machine dient u zich ervan te overtuigen dat u de handleiding goed heeft gelezen en begrepen.

Breng geen veranderingen aan en voer geen onderhoudswerkzaamheden uit die niet in deze handleiding vermeld staan.

De fabrikant kan niet verantwoordelijk worden gehouden voor lichamelijke schade of schade aan eigendommen die zijn veroorzaakt door verkeerd gebruik van de machine of het onjuist interpreteren van de handleiding.



In geval van twijfel of problemen bij het gebruik, zelfs als het niet staat vermeldt, raadpleeg uw leverancier.



1.1 Gebruiksomgeving

- De machine dient uitsluitend professioneel gebruikt te worden in een industriële omgeving.
De fabrikant is niet verantwoordelijk voor schade veroorzaakt door het gebruik van de machine in een huiselijke omgeving.
- De omgevingstemperatuur voor gebruik van de machine moet liggen tussen -10°C en $+40^{\circ}\text{C}$ (Tussen $+14^{\circ}\text{F}$ en $+104^{\circ}\text{F}$).
Voor transport en opslag moet de temperatuur liggen tussen -25°C en $+55^{\circ}\text{C}$ (tussen -13°F en $+131^{\circ}\text{F}$).
- De machine moet worden gebruikt in een stofvrije omgeving zonder zuren, gas of andere corrosieve stoffen.
- De vochtigheidsgraad van de werkomgeving van de machine mag niet hoger zijn dan 50% bij 40°C (104°F).
- De machine kan worden gebruikt tot op een hoogte van 2000 meter boven de zeespiegel (6500 voet).

2 RC 120

2.1 Algemene informatie

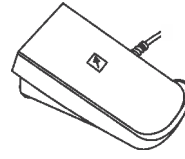

De afstandbediening gaat werken door hem aan te sluiten op de generator. Deze aansluiting kan ook worden gemaakt met de stroom ingeschakeld.

Als de RC afstandbediening is aangesloten kunnen op het bedieningspaneel alle

mogelijke wijzigingen worden uitgevoerd. De wijzigingen op het bedieningspaneel van de generator zijn ook zichtbaar op de display van de afstandbediening en andersom.

De stroomtoevoer gecontroleerd van minimale tot maximale waarde (kan bij set up worden ingevoerd) door met de voet het pedaal te bedienen.

Bij minimale druk levert een microschakelaar het signaal om met het lassen te beginnen.

“Raadpleeg de handleiding”.

3 TECHNISCHE KENMERKEN

RC 120

Netspanning U1	15Vdc
Maximaal opgenomen vermogen (W)	0.2W
Opgenomen stroom I1	15mA
Constructienormen	EN 60974-1/EN 60974-10
Afmetingen (l x p x h)	260x125x160 mm
Gewicht	2.2 Kg.
Stroomtoevoerkabel	6m

INNEHÅLLSFÖRTECKNING

1 VARNING.....	33
1.1 Driftsmiljö.....	33
2 RC 120.....	33
2.1 Allmänt.....	33
3 TEKNISKA DATA.....	34

1 VARNING



Läs den här instruktionsboken ordentligt och se till att du har förstått anvisningarna innan du börjar arbeta med maskinen.

Modifiera inte maskinen och utför inget underhåll som inte anges här.

Tillverkaren påtar sig inget ansvar för person- eller sakskador som uppkommer till följd av att denna instruktionsbok inte har lästs uppmärksamt eller att instruktionerna i den inte har följts.



Rådfråga fackman om du är tveksam till hur aggregatet ska användas eller om du får problem.



1.1 Driftsmiljö

- Denna apparat får endast användas för professionellt bruk i industrimiljö.
Tillverkaren påtar sig inget ansvar för skador som orsakas av att aggregatet används i hemmiljö.
- Aggregatet ska användas i omgivningar med temperatur på mellan -10 °C och +40 °C (mellan +14 °F och +104 °F).
Aggregatet ska transporteras och förvaras i omgivningar med temperatur på mellan -25 °C och +55 °C (mellan -13 °F och +131 °F).
- Miljön ska vara fri från damm, syror, gaser och andra frätande ämnen.
- Den relativa luftfuktigheten ska vara högst 50 % vid 40 °C (104 °F).
Den relativa luftfuktigheten ska vara högst 90 % vid 20 °C (68 °F).
- Aggregatet får användas på en höjd av högst 2000 m över havet (6500 fot).

2 RC 120

2.1 Allmänt

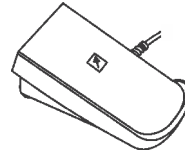

När fjärrstyrningen kopplas till uttaget som finns på generatorerna, aktiveras funktionen automatiskt. Koppling kan ske också när anläggningen är i drift.

När fjärrstyrningen RC är inkopplad, hindrar den inte regleringar och ändringar på generatorns styrpanel. Inställningsändringar på styrpanelen visas på fjärrstyrningen RC och vice versa.

Ställs utgångsströmmen om från ett minimi- till ett maximivärde (som ställs in i SET-UP) genom att vinkeln mellan fotens stödyta och pedalens underdel ändras. Vid minsta tryck ger en mikro-brytare signal om att svetsningen kan starta.

Se Användarhandboken.

3 TEKNISKA DATA

RC 120

Nätspänning U1	15Vdc
Maximal upptagen spänning (W)	0.2W
Strömförbrukning I1	15mA
Konstruktionsbestämmelser	EN 60974-1/EN 60974-10
Mått (lxbxh)	260x125x160 mm
Vikt	2.2 Kg.
Elsladd	6m

INDHOLDSFORTEGNELSE

1 ADVARSEL	37
1.1 Brugsomgivelser	37
2 RC 120.....	37
2.1 Almene oplysninger	37
3 TEKNISKE SPECIFIKATIONER	38

1 ADVARSEL



Inden der udføres nogen form for indgreb, skal man have læst og forstået denne vejledning.

Der må ikke udføres ændringer på maskinen eller vedligeholdelse, der ikke er beskrevet i vejledningen. Fabrikanten påtager sig intet ansvar for legemsbeskadigelser eller beskadigelse af ting, opstået på grund af manglende læsning eller udførelse af indholdet i denne vejledning.



Tag kontakt til en fagmand i tilfælde af tvivl eller problemer omkring anlæggets brug, også selvom problemet ikke omtales heri.



1.1 Brugsomgivelser

- Dette apparat må udelukkende anvendes til professionelle formål i industrielle omgivelser.
Fabrikanten fralægger sig ethvert ansvar for skader forårsaget af anlæggets brug i private omgivelser.
- Anlægget skal anvendes i omgivelser med en temperatur på mellem -10°C og +40°C (mellem +14°F og +104°F).
Anlægget skal transporteres og opbevares i omgivelser med en temperatur på mellem -25°C og +55°C (mellem -13°F og 131°F).
- Anlægget skal benyttes i omgivelser uden støv, syre, gas eller andre ætsende stoffer.
- Anlægget skal benyttes i omgivelser med en relativ luftfugtighed på højst 50 % a 40°C (104°F).
Anlægget skal benyttes i omgivelser med en relativ luftfugtighed på højst 90 % ved 20°C (68°F).
- Anlægget må ikke benyttes i en højde over havet på over 2000m (6500 fod).

2 RC 120

2.1 Almene oplysninger

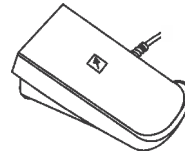

Når fjernbetjeningen slutes til den relevante konektor på generatoren, aktiveres fjernbetjeningsfunktionen.

Tilslutningen kan både udføres med tændt og slukket anlæg.

Generatorens betjeningspanel vil forblive aktivt og kan afvikle en hvilken som helst modifikation, når fjernbetjeningen er sluttet til. Modifikationerne på generatorens betjeningspanel vises også på fjernbetjeningens betjeningspanel og omvendt.

Variere udgangsstrømmen fra en minimumsværdi til en maksimumsværdi (kan indstilles fra SETUP) ved ændring af fodens tryk på pedalen. En mikroafbryder afgiver et signal for start af svejsningen ved selv det mindste tryk.

“Se i instruktionsmanualen”.

3 TEKNISKE SPECIFIKATIONER

RC 120

Forsyningsspænding U1	15Vdc
Maks. effekt optaget (W)	0.2W
Strøm optaget I1	15mA
Bygningsstandarder	EN 60974-1/EN 60974-10
Dimensioner (lxdxh)	260x125x160 mm
Vægt	2.2 Kg.
Forsyningskabel	6m

INNHOLDSFORTEGNELSE

1 ADVARSEL	41
1.1 Bruksmiljø.....	41
2 RC 120.....	41
2.1 Generelt	41
3 TEKNISK SPESIFIKASJON.....	42

1 ADVARSEL



Før du begynner operasjonene, må du forsikre deg om å ha lest og forstått denne håndboka. Utfør ikke modifiseringer eller vedlikeholdsarbeid som ikke er beskrevet.

Produsenten er ikke ansvarlig for skader på personer eller ting som oppstår på grunn av mangelfull forståelse eller manglende utførelse av instruksjonene i denne håndboka.

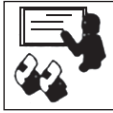

Ved tvil og problemer om bruken av anlegget, skal du henvende deg til kvalifisert personell.



1.1 Bruksmiljø

- Dette apparatet må brukes kun i profesjonelle applikasjoner i industrimiljøer.
Fabrikken er ikke ansvarlig for skader som beror på privat bruk av maskinen.
- Anlegget skal brukes i miljøer med en temperatur mellom -10°C og $+40^{\circ}\text{C}$ (mellom $+14^{\circ}\text{F}$ og $+104^{\circ}\text{F}$).
Anlegget skal transporteres og oppbevares i miljøer med en temperatur mellom -25°C og $+55^{\circ}\text{C}$ (mellom -13°F og 131°F).
- Anlegget skal brukes i miljøer fritt for støv, syre, gass eller andre etsende stoffer.
- Anlegget må ikke brukes i miljøer med en luftfuktighet over 50% ved 40°C (104°F).
Anlegget må ikke brukes i miljøer med en luftfuktighet over 90% ved 20°C (68°F).
- Anlegget må ikke brukes høyere enn 2000m over havet.

2 RC 120

2.1 Generelt

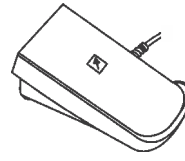

Koplingen av fjernstyringskontrollen til tilsvarende kontakt som befinner seg på generatorene, aktiverer dens funksjon. Denne kopling kan også gjøres når anlegget er igang.

Når fjernstyringskontrollen RC er tilkople, forblir generatorens kontrollpanel aktivert for eventuelle endringer. Endringene på generatorens kontrollpanel blir også vist på RC-kontrollen og omvendt.

Blir utgangsstrømmen variert fra et min. til et maks. verdi (som kan bli innstilt fra SETUP) ved å variere fottrykket på pedalfalten. En mikrobryter forsyner enheten med signal for sveisebegynnelse ved minste trykk.

“Konsulter instruksjonshåndboka”.

3 TEKNISK SPESIFIKASJON

RC 120

Strømforsyningsspenning U1	15Vdc
Maksimal effekt absorbert (W)	0.2W
Absorbert strøm I1	15mA
Produksjonsnormer	EN 60974-1/EN 60974-10
Mål (lxdxh)	260x125x160 mm
Vekt	2.2 Kg.
Nettkabel	6m

SISÄLLYS

1 VAROITUS	45
1.1 Työskentelytila	45
2 RC 120.....	45
2.1 Yleistä	45
3 TEKNISET OMINAISUUDET	46

1 VAROITUS



Ennen työskentelyä laitteella, varmista että olet lue-
nut ja ymmärtänyt tämän käyttöohjeen sisällön.
Älä tee muutoksia tai huoltotoimenpiteitä, joita ei
ole kuvattu tässä ohjeessa.

Valmistajaa ei voida pitää syällisenä henkilö- tai
omaisuusvahinkoihin, jotka aiheutuvat tämän materiaalin huoli-
mattomasta lukemisesta tai virheellisestä soveltamisesta.



Käänny ammattitaitoisen henkilön puoleen epäsel-
vissä tapauksissa sekä koneen käyttöön liittyvissä
ongelmissa, myös sellaisissa tapauksissa, joihin näis-
sä ohjeissa ei ole viitattu.



1.1 Työskentelytila

- Tämä laite on suunniteltu vain ammattimaiseen käyttöön
teollisessa ympäristössä.
Valmistaja ei vastaa vahingoista, jotka ovat aiheutuneet siitä,
että laitetta on käytetty kotitaloudessa.
- Laitetta tulee käyttää tiloissa, joiden lämpötila on -10°C ja
 $+40^{\circ}\text{C}$ välillä ($+14^{\circ}\text{F}$... $+104^{\circ}\text{F}$).
Laitetta tulee kuljettaa ja varastoida tiloissa, joiden lämpötila
on -25°C ja $+55^{\circ}\text{C}$ välillä (-13°F ... 131°F).
- Laitetta ei saa käyttää tiloissa, joissa on pölyä, happoja, kaasua
tai muita syövyttäviä aineita.
- Laitetta ei saa käyttää tiloissa, joiden suhteellinen kosteus on
yli 50%, 40°C :ssa (104°F).
Laitetta ei saa käyttää tiloissa, joiden suhteellinen kosteus on
yli 90%, 20°C :ssa (68°F).
- Laitetta tulee käyttää korkeintaan 2000m (6500 jalkaa)
merenpinnan yläpuolella.

2 RC 120

2.1 Yleistä

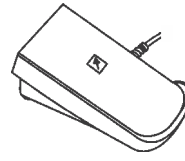

Kun RC kaukosäädin liitetään generaatto-
reissa olevaan liittimeen, sen toiminta
aktivoituu. Liitäntä voidaan suorittaa
myös laitteen ollessa käynnissä.

RC kaukosäätimen ollessa kytkettynä, voi-
daan generaattorin ohjauspaneelista suo-
ritttaa kaikkia muutoksia. Generaattorin ohjauspaneelissa tehdyt
muutokset siirtyvät myös RC kaukosäätimeen ja päinvastoin.
Poistovirtaa voidaan muuttaa minimi- ja Maksimiarvojen välillä
olevalla arvolla (voidaan asettaa SETUP'ista), muuttamalla pol-
kimella olevan jalan ja polkimen alaosan välistä kulmaa. Aivan
kevytkin painallus saa mikrokytkimen lähettämään hitsaustapah-
tuman alkamisen signaalin.

“Katso lisätietoja käyttöohjekirjasta”.

3 TEKNISET OMINAISUUDET

	RC 120
Syöttöjännite U1	15Vdc
Maksimi ottoteho (W)	0.2W
Ottovirta I1	15mA
Standardit	EN 60974-1/EN 60974-10
Mitat (lxsxk)	260x125x160 mm
Paino	2.2 Kg.
Syöttökaapeli	6m

ΠΕΡΙΕΧΟΜΕΝΑ

1 ΠΡΟΕΙΔΟΠΟΙΗΣΕΙΣ	49
1.1 Περιβάλλον χρήσης	49
2 RC 120.....	49
2.1 Γενικά.....	49
3 ΤΕΧΝΙΚΑ ΧΑΡΑΚΤΗΡΙΣΤΙΚΑ.....	50

1 ΠΡΟΕΙΔΟΠΟΙΗΣΕΙΣ



Πριν προβείτε σε οποιαδήποτε ενέργεια, πρέπει να διαβάσετε και να είστε βέβαιοι ότι κατανοήσατε το παρόν εγχειρίδιο.

Μην κάνετε μετατροπές και ενέργειες συντήρησης που δεν περιγράφονται στο παρόν.

Ο κατασκευαστής δε φέρει καμία ευθύνη για τυχόν βλάβες, σε πρόσωπα ή πράγματα, που οφείλονται σε πλημμελή ανάγνωση και/ή μη εφαρμογή των οδηγιών του παρόντος εγχειριδίου.



Για κάθε αμφιβολία ή πρόβλημα σχετικά με τη χρήση της διάταξης, έστω κι αν δεν περιγράφεται εδώ, συμβουλευτείτε κάποιον εξειδικευμένο τεχνικό.



1.1 Περιβάλλον χρήσης

- Η συσκευή πρέπει να προορίζεται μόνο για επαγγελματική χρήση, σε βιομηχανικό περιβάλλον.
Ο κατασκευαστής δε φέρει καμία ευθύνη για βλάβες που ενδεχομένως προκληθούν εξαιτίας της χρήσης της διάταξης μέσα σε κατοικίες.
- Η διάταξη πρέπει να χρησιμοποιείται σε χώρους με θερμοκρασία μεταξύ -10°C και $+40^{\circ}\text{C}$ ($+14^{\circ}\text{F}$ και $+104^{\circ}\text{F}$).
Η διάταξη πρέπει να μεταφέρεται και να αποθηκεύεται σε χώρους με θερμοκρασία μεταξύ -25°C και $+55^{\circ}\text{C}$ (-13°F και 131°F).
- Η διάταξη πρέπει να χρησιμοποιείται σε περιβάλλον χωρίς σκόνη, οξέα, αέρια ή άλλες διαβρωτικές ουσίες.
- Η διάταξη πρέπει να χρησιμοποιείται σε περιβάλλον με σχετική υγρασία μικρότερη του 50%, στους 40°C ($40,00^{\circ}\text{C}$).
Η διάταξη πρέπει να χρησιμοποιείται σε περιβάλλον με σχετική υγρασία μικρότερη του 90%, στους 20°C (68°F).
- Το μέγιστο επιτρεπόμενο υψόμετρο για τη χρήση της διάταξης είναι 2000 μ. (6500 πόδια).

2 RC 120

2.1 Γενικά

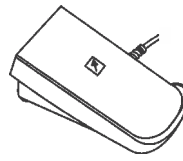

Με σύνδεση του τηλεχειριστηρίου στην ειδική υποδοχή, που υπάρχει στις γεννήτριες, ενεργοποιείται αυτόματα και η λειτουργία του. Αυτή η σύνδεση μπορεί να γίνει ακόμα και με την συσκευή αναμμένη.

Με το τηλεχειριστήριο RC συνδεδεμένο, ο πίνακας ελέγχου της γεννήτριας παραμένει ενεργός και μπορείτε να κάνετε οποιαδήποτε αλλαγή. Οι ρυθμίσεις που γίνονται από τον πίνακα ελέγχου της γεννήτριας εμφανίζονται και στο τηλεχειριστήριο RC και αντίστροφα.

Το ρεύμα εξόδου αρχίζει να κυμαίνεται από μία ελάχιστη σε μία μέγιστη τιμή (οι οποίες επιλέγονται από το SET-UP), ανάλογη με τη μεταβολή της γωνίας μεταξύ επιφάνειας στήριξης του ποδιού και βάσης του πεντάλ. Ένας μικροδι-ακόπτης παρέχει, με την ελάχιστη πίεση, το σήμα έναρξης της συγκόλλησης.

Συμβουλευτείτε το εγχειρίδιο οδηγιών χρήσης της διάταξης.

3 ΤΕΧΝΙΚΑ ΧΑΡΑΚΤΗΡΙΣΤΙΚΑ

RC 120

Τάση τροφοδοσίας U1	15Vdc
Μέγ. απορροφούμενη ισχύς (W)	0.2W
Απορρόφηση ρεύματος I1	15mA
Πρότυπα κατασκευής	EN 60974-1/EN 60974-10
Διαστάσεις (ΠxΒxΥ)	260x125x160 mm
Βάρος	2.2 Kg.
Καλώδιο τροφοδοσίας	6m

4 Targa dati, Rating plate, Leistungsschilder, Plaque données, Placa de características, Placa de dados, Technische gegevens, Märklät, Dataskilt, Identifikasjonsplate, Arvokilpi, πινακίδα χαρακτηριστικών

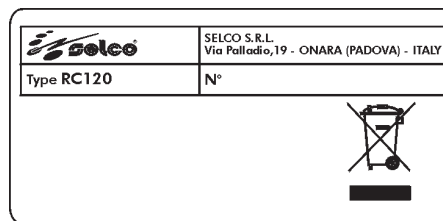

Non collocare l'apparecchiatura elettrica tra i normali rifiuti!
In osservanza alla Direttiva Europea 2002/96/EC sui Rifiuti di Apparecchiature Elettriche ed Elettroniche e alla sua implementazione in accordo con le leggi nazionali, le apparecchiature elettriche che hanno raggiunto la fine del ciclo di vita devono essere raccolte separatamente e inviate ad un centro di recupero e smaltimento. Il proprietario dell'apparecchiatura dovrà identificare i centri di raccolta autorizzati informandosi presso le Amministrazioni Locali.
L'applicazione della Direttiva Europea permetterà di migliorare l'ambiente e la salute umana.

Do not dispose of electrical equipment together with normal waste!
In observance of European Directive 2002/96/EC on Waste Electrical and Electronic Equipment and its implementation in accordance with national law, electrical equipment that has reached the end of its life must be collected separately and returned to an environmentally compatible recycling facility. As the owner of the equipment, you should get information on approved collection systems from our local representative.
By applying this European Directive you will improve the environment and human health!

Das Elektrogerät nicht in den normalen Hausmüll geben!
Unter Beachtung der Europäischen Richtlinie 2002/96/EC über Elektro- und Elektronikaltgeräte und ihrer Anwendung gemäß den nationalen Gesetzen müssen Elektrogeräte, die am Ende ihrer Lebensdauer angelangt sind, gesondert gesammelt und einer Recycling- und Entsorgungsstelle übergeben werden. Der Eigentümer des Geräts muss sich bei den Örtlichen Verwaltungen über die autorisierten Sammelstellen informieren.
Durch die Einhaltung der Europäischen Richtlinie schützen Sie die Umwelt und die Gesundheit Ihrer Mitmenschen.

Ne pas éliminer les équipements électriques avec les déchets ménagers !
En application de la Directive Européenne 2002/96/EC relative aux déchets d'équipements Electriques et Electroniques et de son implémentation conformément aux lois nationales, les équipements électriques à éliminer doivent être jetés séparément et envoyés à un centre de récupération et d'élimination. Le propriétaire de l'appareillage devra s'informer sur les centres de collecte autorisés auprès des Administrations Locales.
L'application de la Directive Européenne permettra de respecter l'environnement et la santé des êtres humains.

¡No arroje nunca el equipo eléctrico entre los residuos comunes!
Respetando la Directiva Europea 2002/96/EC sobre los Residuos de Equipos eléctricos y Electrónicos y su aplicación de acuerdo con las leyes nacionales, los equipos eléctricos que llegaron al final de su ciclo de vida deben recogerse por separado y enviarse a un centro de reciclaje y eliminación. El propietario del equipo deberá identificar los centros de recogida autorizados, informándose en las Administraciones locales.
La aplicación de la Directiva Europea permitirá mejorar el medio ambiente y la salud humana.

5 Significato targa dati, Meaning rating plate, Bedeutung der Angaben auf dem Leistungsschild, Signification de la plaque des données, Significado de la etiqueta de los datos, Significado da placa de dados, Betekenis gegevensplaatje, Märkplåt, Betydning af oplysningerne dataskilt, Beskrivelse informasjonsskilt, Kilven sisältö, Σημασία πινακίδας χαρ ακτηριότικών

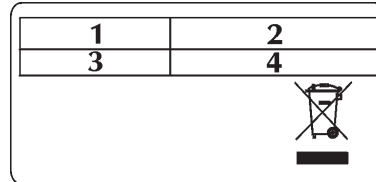

ITALIANO

- 1 Marchio di fabbricazione
- 2 Nome ed indirizzo del costruttore
- 3 Modello dell'apparechiatura
- 4 N° di serie

ENGLISH

1. Trademark
2. Name and address of manufacturer
3. Machine model
4. Serial no.

DEUTSCH

- 1 Marke
- 2 Herstellername und -adresse
- 3 Gerätemodell
- 4 Seriennummer

FRANÇAIS

- 1 Marque de fabrique
- 2 Nom et adresse du constructeur
- 3 Modèle de l'appareil
- 4 N° de série

ESPAÑOL

- 1 Marca de fabricación
- 2 Nombre y dirección del fabricante
- 3 Modelo del aparato
- 4 N° de serie

6 Schema-Connettori, Diagram-Connectors, Schaltplan-Verbinder, Schéma-Connecteurs, Esquema-Conectores, Diagrama-Conectores, Schema-Verbindingen, kopplingschema-Kontaktton, Oversigt-Konnektorer, Skjema-Skjøtemunnstykker, Kytentäkaavio-Liittimet, Διαγράμμα-Συνδετήρες

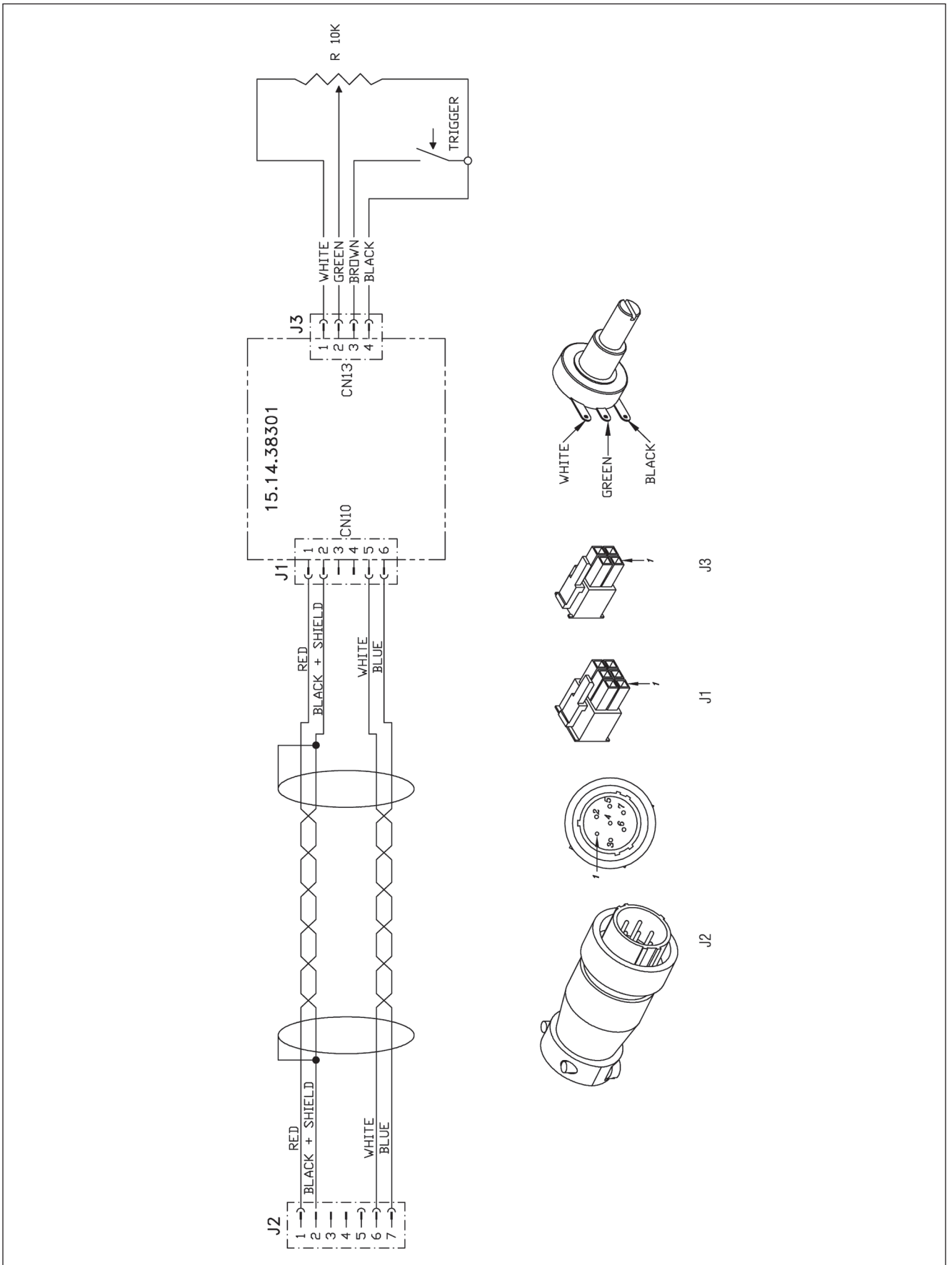

7 Lista ricambi, Spare parts list, Ersatzteilverzeichnis, Liste de pièces détachées, Lista de repuestos, Lista de peças de reposição, Lijst van reserve onderdelen, Reservdelslista, Reservdelsliste, Liste over reservedeler, Varaosaluettelo, καταλογος ανταλλακτικων

71.02.197 RC 120

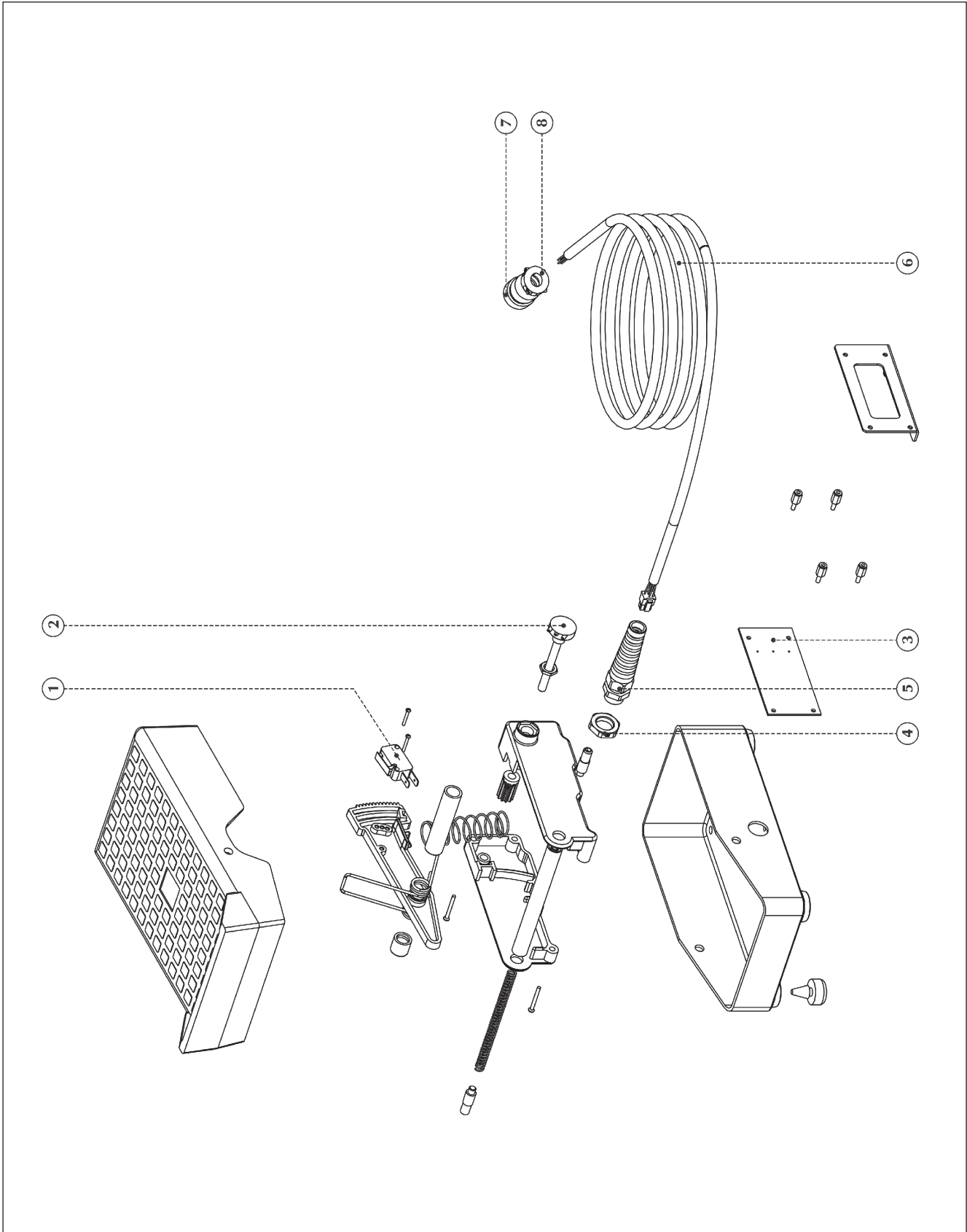





POS. CODE	ITALIANO	ENGLISH	DEUTSCH	FRANÇAIS	ESPAÑOL
1	02.06.009	Microswitch	Mikroschalter	Micro switch	Micro interruptor
2	02.06.006	Potenzíometro	Potentiometer	Potentiomètre	Potenciómetro
3	15.14.38331	Scheda elettronica	Elektronische Karte	Platine	Tarjeta electrónica
4	08.22.006	Controdado	Kontermutter	Contre-écrou	Contratuercia
5	08.22.005	Pressacavo	Kabelklemme	Serre-cable	Racor para cable
6	49.04.043	Cavo alimentazione comando	Kabel für fernregler	Câble contrôle	Cable de control
7	10.05.033	Connettore 7 contatti maschio	7-Polige Kupplungstecker (male)	Connecteur 7 contacts mâle	Conector 7 polos macho
8	10.01.103	Pressacavo	Kabelklemme	Serre-câble	Racor para cable
*	91.08.382	Manuale istruzione "A"	Bedienungsanweisungen "A"	Manuel d'instructions "A"	Manual instrucciones "A"
*	91.08.383	Manuale istruzione "B"	Bedienungsanweisungen "B"	Manuel d'instructions "B"	Manual instrucciones "B"

"A" = IT-CB-DE-FR-ES-NL-DK-FI-SE-NO-CR-PT





"B" = CZ-PL-RU-TR-RO-BG-SK

8 Simbologia, Symbols, Symbole, Symbologie, Símbolos, Simbolos, Symbolen, Symboler, Symboler, Symbolenes forklaring, Symbolit, Συμβολα





ITALIANO

-   Leggere il manuale istruzione
-  Consultare personale qualificato
-  Ambiente di utilizzo





ENGLISH

-   Read the instruction manual
-  Consult qualified personnel
-  Environment of use





DEUTSCH

-   Lesen Sie die Bedienungsanleitung
-  Fachpersonal kontaktieren
-  Arbeitsumgebung





FRANÇAIS

-   Lire le manuel d'instructions
-  Consulter un personnel qualifié
-  Usage prévu





ESPAÑOL

-   Lea el manual de instrucciones
-  Consultar con el personal cualificado
-  Entorno de utilización





PORTUGUÊS

-   Ler o manual de instruções
-  Consultar o pessoal qualificado
-  Ambiente de utilização





NEDERLANDS

-   Lees de handleiding
-  Vakbekwaam personeel raadplegen
-  Gebruiksomgeving





SVENSKA

-   Läs instruktionsboken
-  Konsultera en fackman
-  Driftsmiljö





DANSK

-   Læs brugervejledningen
-  Tag kontakt til udlært personale
-  Brugsomgivelser





NORSK

-   Læs brukervejledningen
-  Tag kontakt til udlært personale
-  Brugsomgivelser

SUOMI

-   Lue hyvin käyttöohjeet
-  Ota yhteys ammattimieheen
-  Työskentelytila

ΕΛΛΗΝΙΚΑ

-   Διαβάστε το εγχειρίδιο οδηγιών
-  Συμβουλευθείτε εξειδικευμένο προσωπικό
-  Περιβάλλον χρήσης

voestalpine

ONE STEP AHEAD.

voestalpine Böhler Welding
www.voestalpine.com/welding