

# SAFETY BARRIERS

## GUARDRAIL SYSTEM 1

driven posts 1 sections

product specification sheet E114

to specification sheet E112

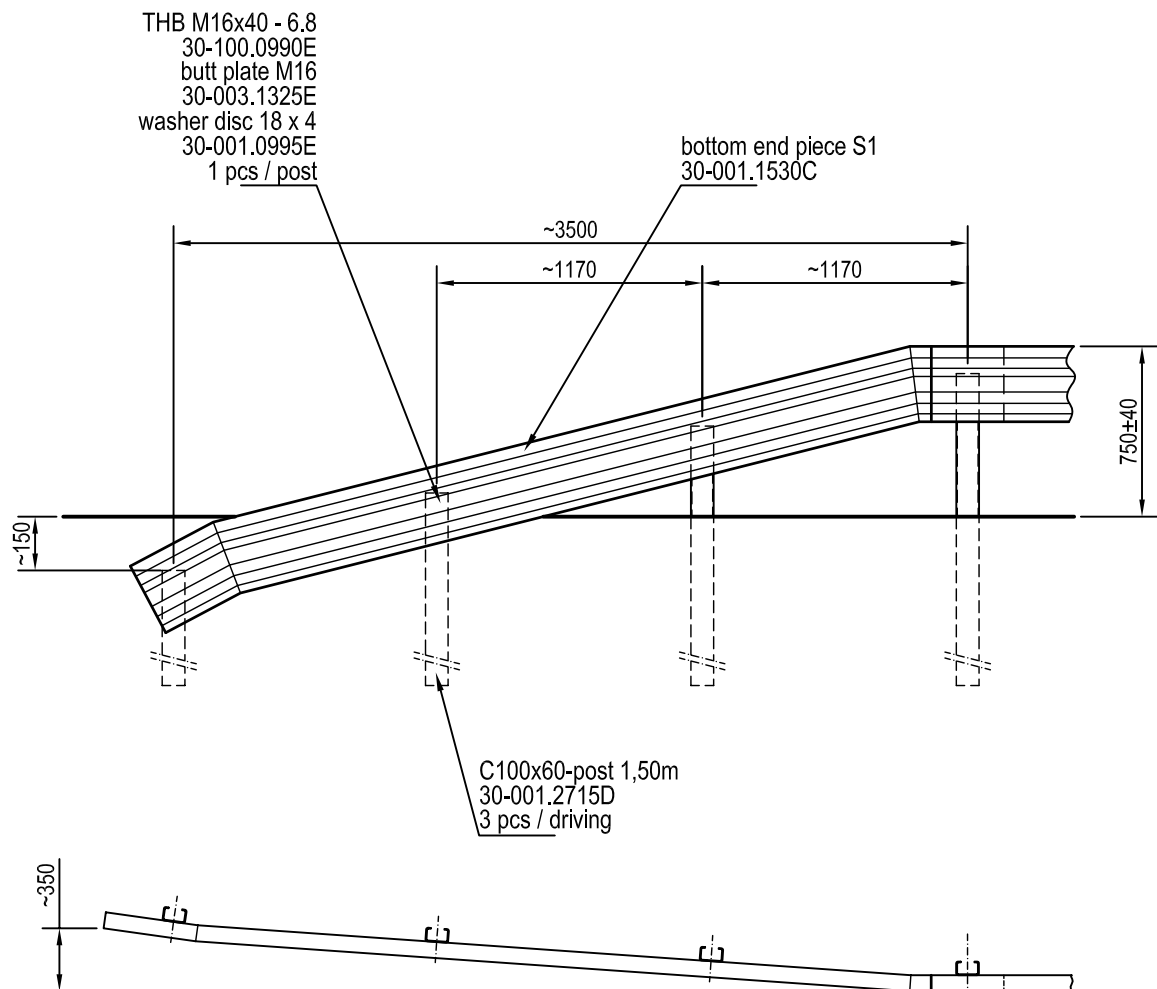

09/2011