

SAFETY BARRIERS

KREMSBARRIER 2 RH2K

**roadside restraint system
on civil structures**

EG certificate of conformity: 0531-CPR-1317-1910

product specifications Sheet C213/1



tested in accordance to EN 1317-2:

containment level:	H2
impact severity level:	B
working width:	W2
system test length:	14 fields or. 53,20m

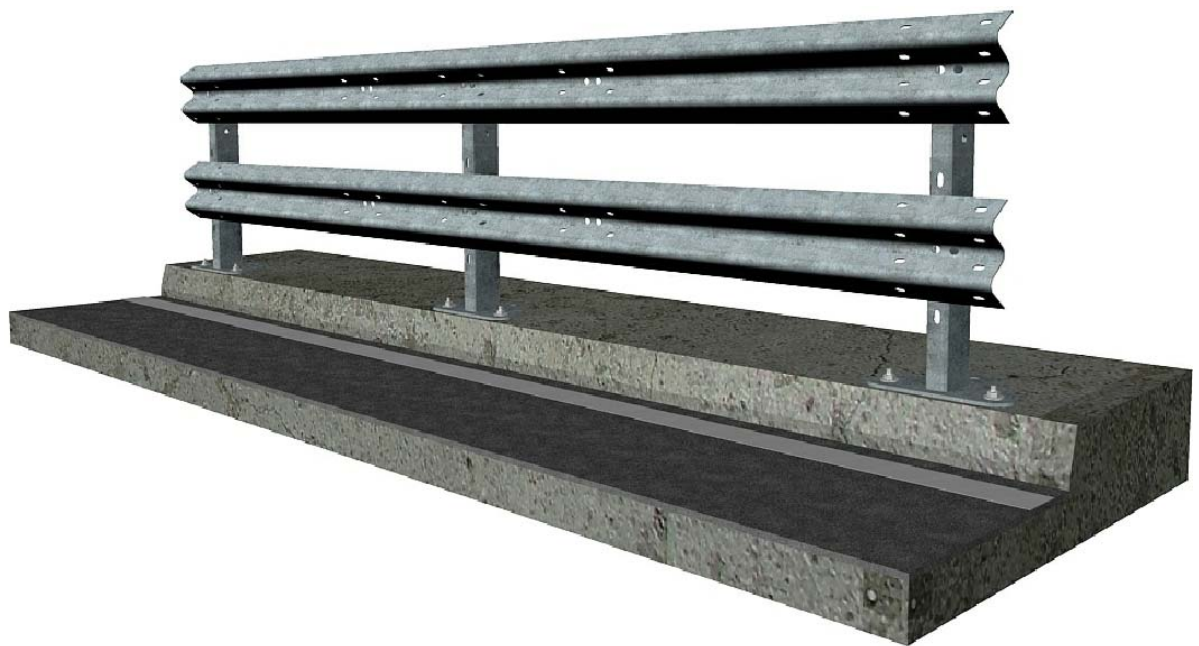

03/2016

SAFETY BARRIERS

KREMSBARRIER 2 RH2K

roadside restraint system
on civil structures

product specifications Sheet C213/2

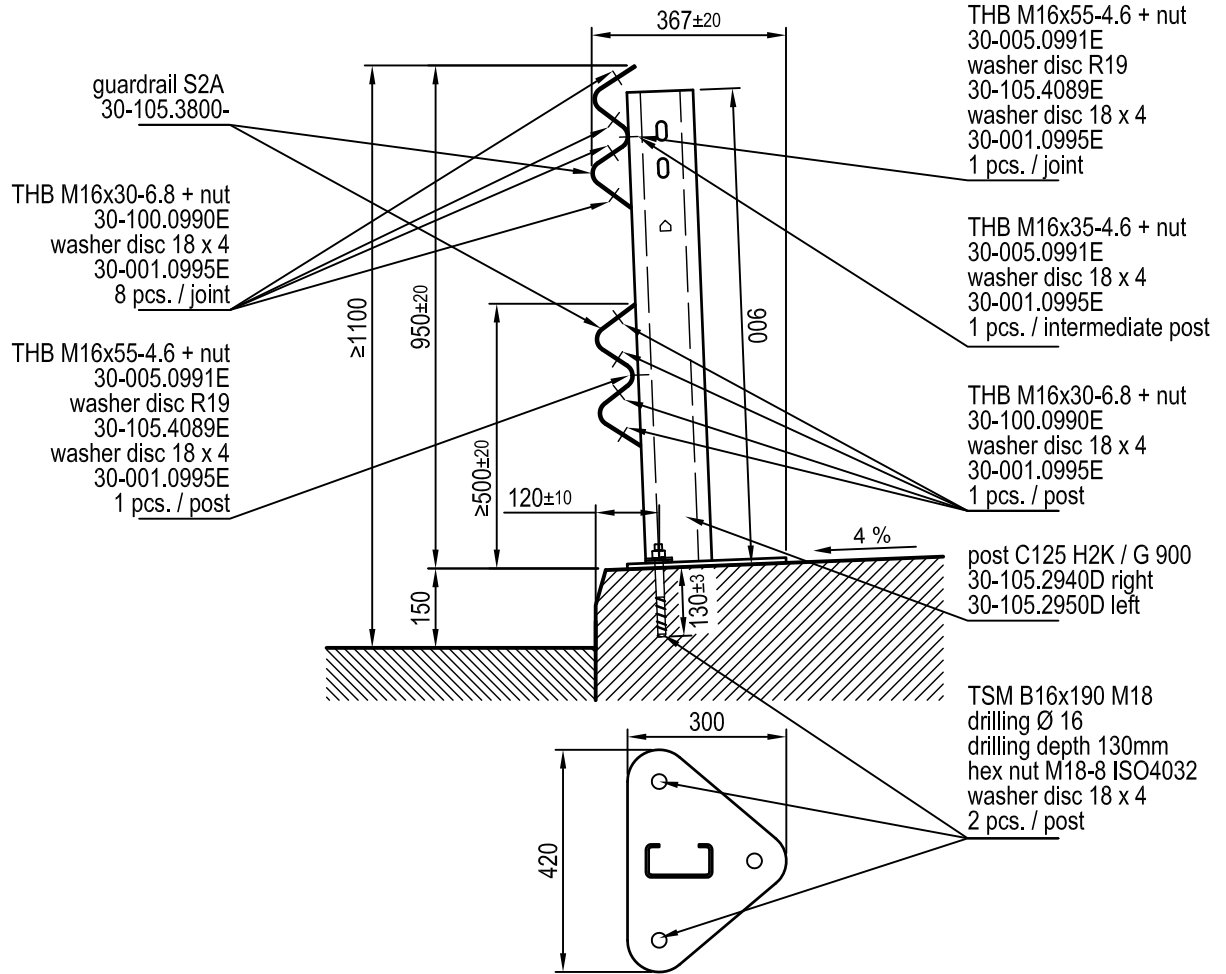

06/2016

SAFETY BARRIERS

KREMSBARRIER 2 RH2K

roadside restraint system
on civil structures

product specifications Sheet C213/3

installation drawing

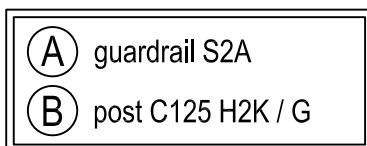
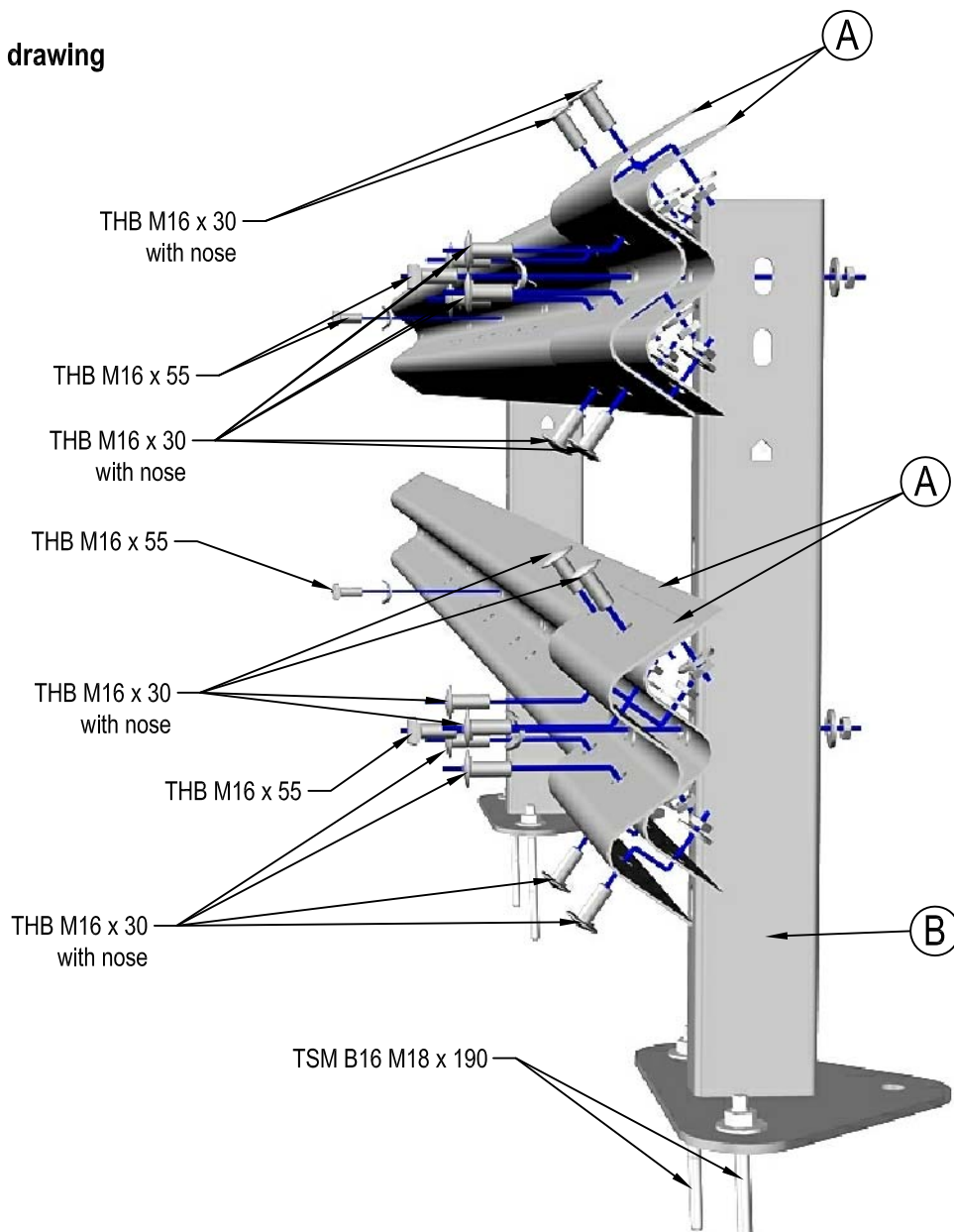

06/2016

SAFETY BARRIERS

KREMSBARRIER 2 RH2K

roadside restraint system
on civil structures

product specifications Sheet C213/4

optional:
rail filling

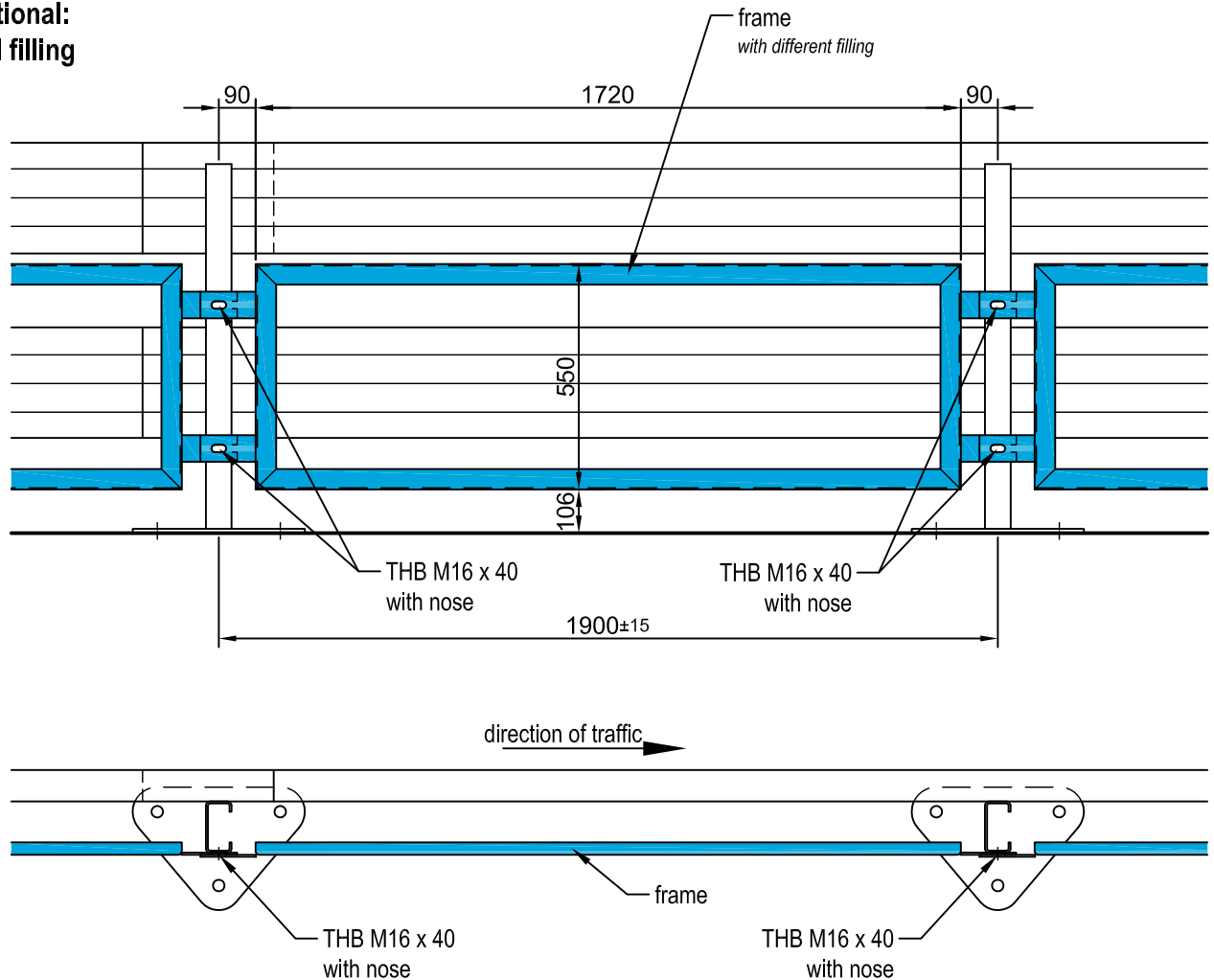

Example of infill

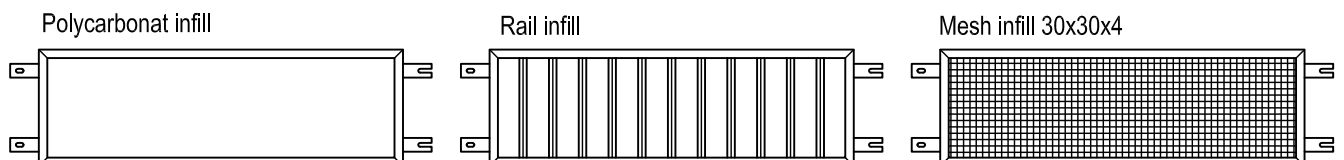

06/2016

SAFETY BARRIERS

KREMSBARRIER 2 RH2K

roadside restraint system
on civil structures

product specifications Sheet C213/5

dilatation ± 100

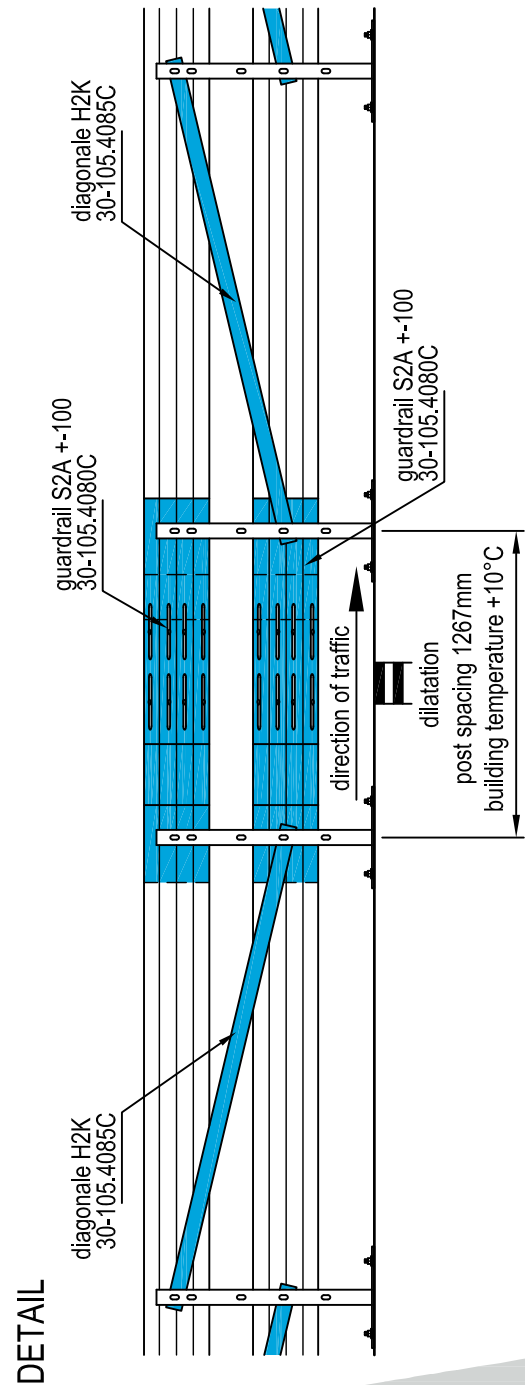
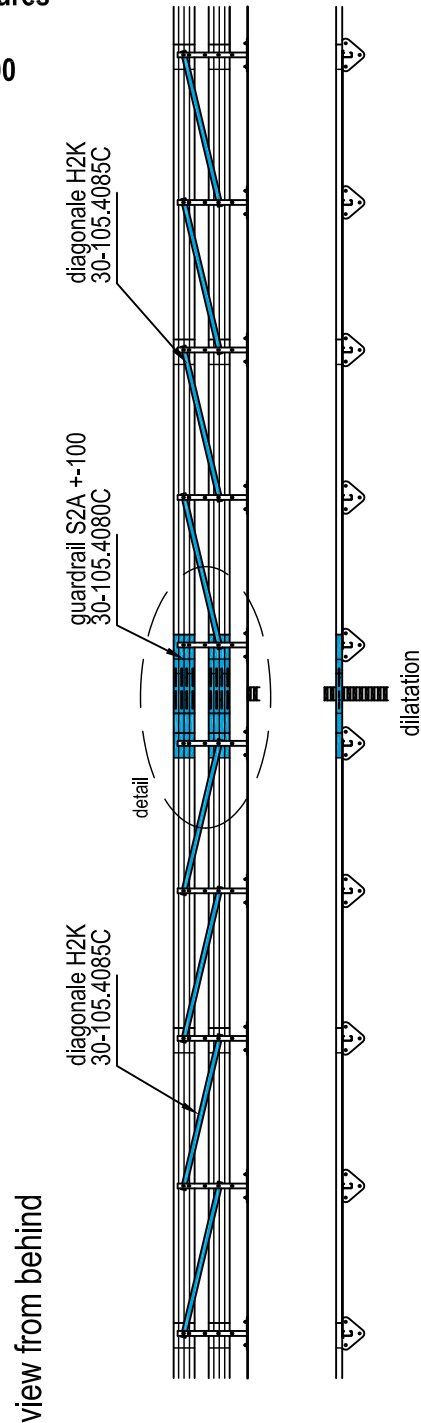

06/2016